

## ⚠ WARNING

**DISCONNECT POWER BEFORE RE-LAMPING OR WIRING THE FIXTURE  
READ ALL INSTRUCTIONS COMPLETELY BEFORE STARTING INSTALLATION.**

## ⚠ CAUTION

- TO AVOID THE RISK OF FIRE OR SHOCK, FIXTURE MUST BE INSTALLED IN COMPLIANCE WITH ALL APPLICABLE NATIONAL AND LOCAL ELECTRICAL/BUILDING CODES.
- INSTALLATION AND MAINTENANCE OF THIS UNIT REQUIRES AN ELECTRICIAN OR CERTIFIED FACTORY TRAINED TECHNICIAN.
- If an existing fixture is being replaced, remove it and note to which of the wires in the outlet box the fixture was attached. DO NOT SEPARATE ANY OTHER WIRES THAT MAY BE IN THE BOX. DO NOT DAMAGE THE INSULATION OF OLDER WIRING. In regular circumstances the BLACK wire will be the "Hot" lead and the WHITE wire will be the "Neutral" or "Common" lead. A GREEN or BARE COPPER wire is the "Ground". In older buildings it is always good practice to reconfirm the polarity of the wiring.

## NOTICE

- The important safeguards and instructions outlined on this sheet cannot cover all possible conditions and situations that may occur. It must be understood that common sense, caution and care factors that cannot be built into any product. Caution and care must be supplied by the person(s) installing, operating and caring of this lighting fixture.
- This fixture is designed to be mounted on a correctly installed on 1/2-13 threaded rod secured to structure and standard round or octagon box or a through wiring box with a plaster frame. The box must be securely mounted to the structure of the building. The crossbar and hardware supplied should be used. Directly mounting the fixture to the outlet box may make it impossible to correctly align the fixture.
- This fixture is supplied with a 4-pcs. stem. There is one 6" section, two 12" section and one 18" section. This feature allows the fixture to be mounted with a stem up to 48" in length in 6" increments.
- This fixture is supplied with a swivel. By rotating the canopy the fixture may be mounted to angled ceiling.

## NOTICE:

**CALIFORNIA PROP 65: THIS LIGHTING FIXTURE CONTAINS CHEMICALS KNOWN TO THE STATE OF CALIFORNIA TO CAUSE CANCER, BIRTH DEFECTS, AND/OR OTHER REPRODUCTIVE HARM. WASH HANDS AFTER USE.**

### FIXTURE PREPARATION

1. Remove the fixture, parts and parts bag(s) from the carton.

#### NOTICE:

- Before discarding the carton, double check to make certain that all parts are found.

### FIXTURE INSTALLATION

1. Attach the modified heavy duty zinc plated strap together with the swivel holder to the junction box. (The green screw should face the floor)  
Place the modified heavy duty zinc plated strap at the junction box and fasten using the round head screw then fasten the 1/2-13 threaded rod with the corresponding nuts. (See Figure-01)

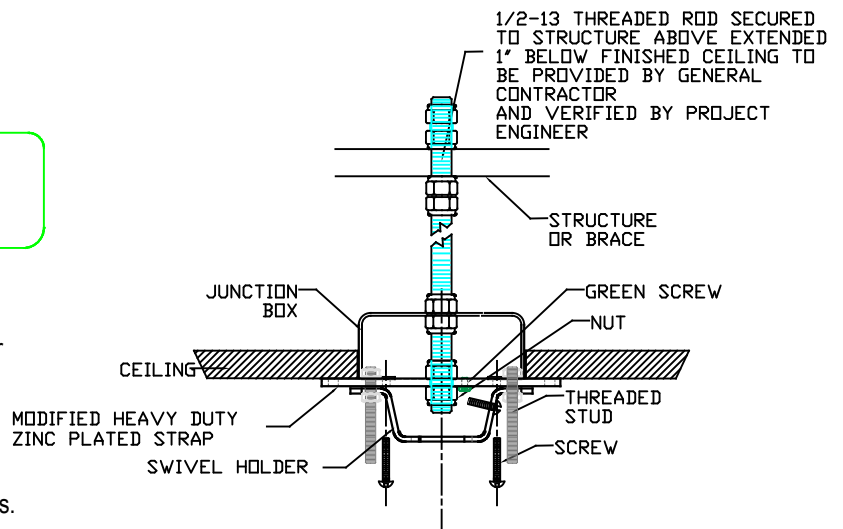

FIGURE-01

- Determine the overall desired length of the fixture. Assemble the adjustable stems one at a time onto the fixture leads. Tape the end of the leads to a stiff wire (coat hanger) to aid in pulling them through the stems. Place the canopy onto the stem. Assemble the ball swivel on the stem.
- Hang the fixture to the swivel holder. Make sure to fit the groove of the swivel ball to the tongue of the swivel holder. Then attach the SAFETY CABLE to the building or structure or brace. (See figure-02)

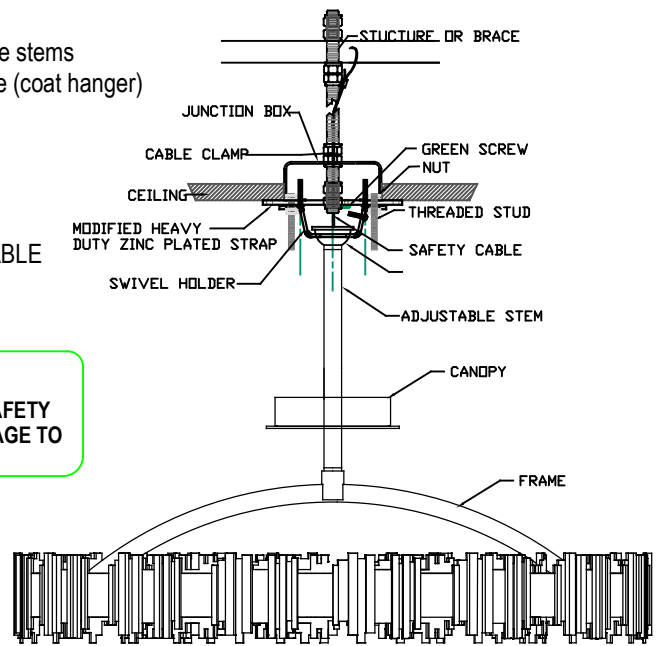

FIGURE-02

- Cut off the excess fixture wire 6" beyond the swivel ball on the stem. Strip  $\frac{1}{2}$ " insulation from the ends of the wire. Twist the wire strands together.
- Fasten the white fixture lead to the white wire in the outlet box. Fasten the wires together with an approved fastener (wire nut). Starting about 1" below the fastener, tightly wrap the connection with electrical tape so that the connections seals the end of the fastener.

**WARNING**  
Make sure that there is no exposed wire or strands that could cause a dangerous short circuit!

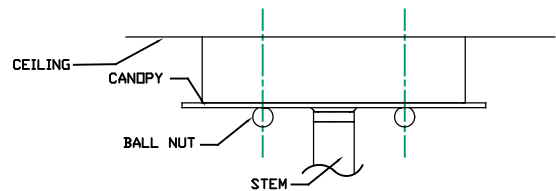
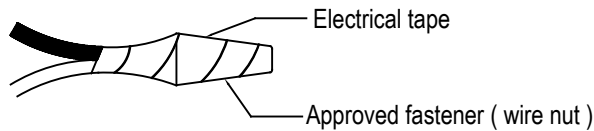

FIGURE-03

- Connect the black fixture lead to the black wire in the outlet box. Fasten the joined wires as in step 5.
- Pull up & attach the canopy to the mounting strap and secure it with ball nuts. (See Figure-03)
- Install glass (smooth surface of the glass must be facing the frame) on the provided threaded rod and secure it with silicone washer. Glass should be in alternate height (See Figure-05). If the glass is loose use the provided thin silicon washer(use 2 as needed).

**WARNING**  
REFER TO THE ILLUSTRATION FOR CORRECT AND SAFE INSTALLATION. FAILURE TO FOLLOW THIS INSTRUCTION COULD RESULT HARM/DAMAGE TO THE FIXTURE, PROPERTY AND/OR PERSON(S)!

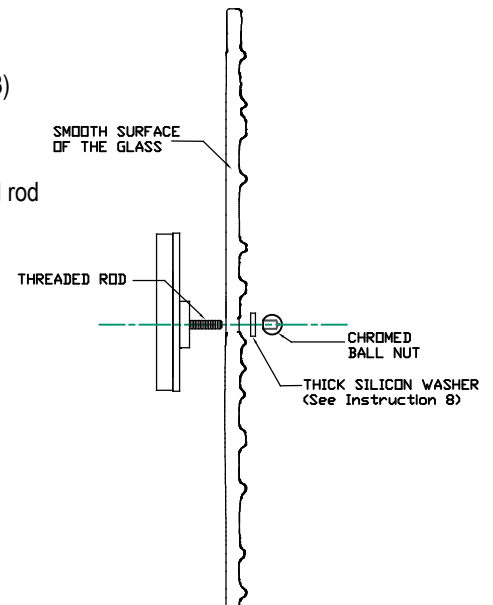

FIGURE-04

9. Install the lamps. (Type - B Lamp).

**NOTICE:**  
This fixture is rated for 60w Type - B Lamp.

**WARNING**

**DO NOT EXCEED RECOMMENDED WATTAGE!**

10. Restore power to the circuit breaker or fuse box.

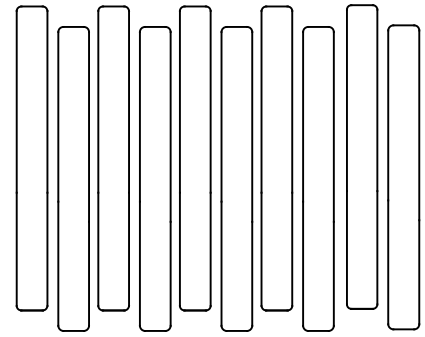
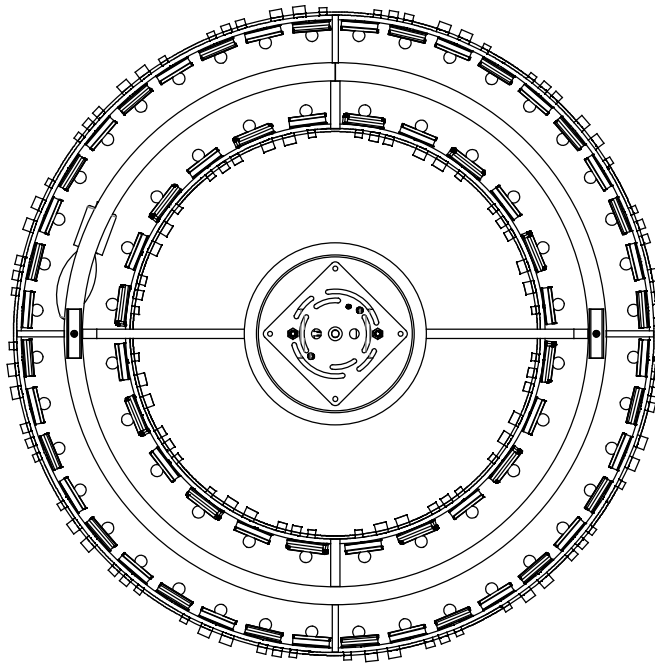

FIGURE-05

## ILLUSTRATION



## PARTS QUANTITY

- 1. Clear Glass - 64 units.
  - Inner Frame - 24 units
  - Outer Frame - 40 units