

### Features

- Single-speed whirlpool offers performance and value, with 8 fully adjustable jets.
- Hydromassage flow and direction can be controlled at each jet.
- Built-in heater.
- Comfort Depth® design offers a convenient 19-inch step-over height while retaining the same depth as a standard 21-inch bath.
- Molded lumbar support offers extra comfort while bathing.
- Slotted overflow allows for deep soaking.
- Integral apron.
- Integral flange helps prevent water from seeping behind wall and simplifies alcove installation.
- Textured bottom surface.
- Left-hand drain.
- Coordinates with other products in the Archer collection.

### Material

- Acrylic

### Hydrotherapy

- Whirlpool

### Installation

- Three-wall alcove.

### Additional Hydrotherapy Options

- Soaking Bath - K-1948-LA
- Soaking Bath + Bask heated surface - K-1948-LAW
- BubbleMassage air bath - K-1949-GLA
- BubbleMassage air bath + Bask heated surface - K-1949-GLAW
- VibrAcoustic - K-1949-VBLA
- VibrAcoustic + Bask heated surface - K-1949-VBLAW
- Whirlpool - K-1949-LA
- Whirlpool + heater - K-1949-HLA
- Whirlpool + Bask heated surface - K-1949-LAW
- Whirlpool + BubbleMassage air bath - K-1949-XHGLA

### Required Products/Accessories

K-7271 Brass Slotted Overflow Bath Drain

or

K-7272 PVC Slotted Overflow Bath Drain

### Recommended Products/Accessories

K-24916 Wireless Music Kit



ADA

### Codes/Standards











ASME A112.19.7/CSA B45.10  
CSA B45.5/IAPMO Z124  
UL 1795  
CSA C22.2 No. 218.2  
ADA  
ICC/ANSI A117.1

**KOHLER® Plastic Baths and Receptors  
Lifetime Limited Warranty  
KOHLER® Hydrotherapy Components  
Five-Year Limited Warranty**

See website for detailed warranty information.

### Available Colors/Finishes

*Color tiles intended for reference only.*

Color	Code	Description
	0	White
	96	Biscuit
	47	Almond
	NY	Dune
	95	Ice™ Grey
	G9	Sandbar
	33	Mexican Sand™
	K4	Cashmere
	58	Thunder™ Grey
	7	Black Black™

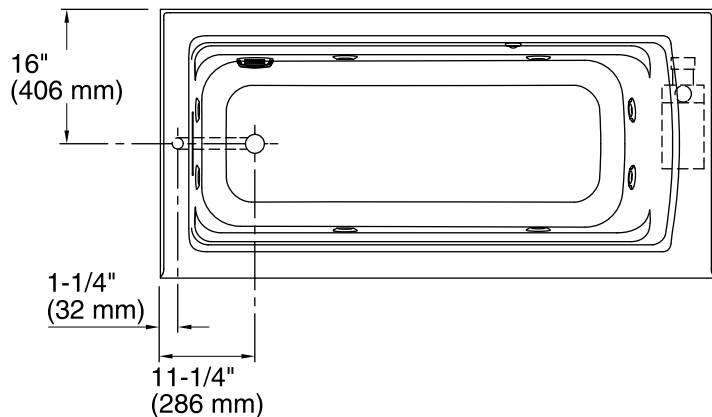

No change in measurements if connected with drain illustrated. (K-7272)

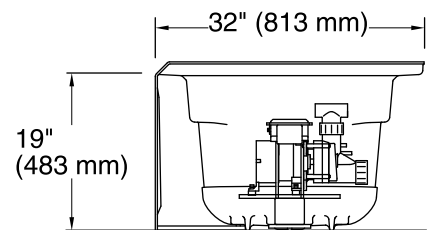
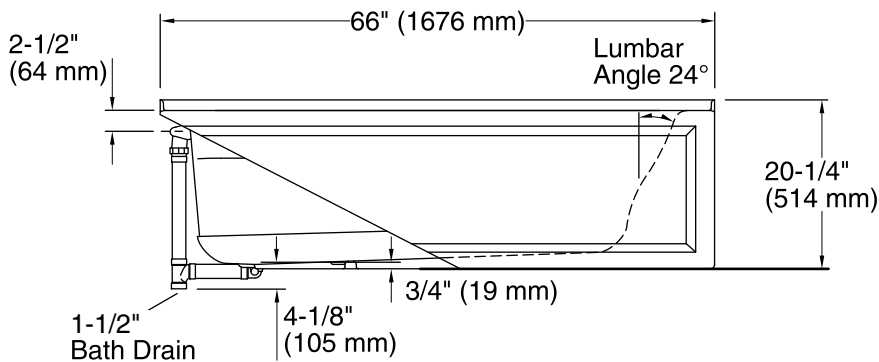
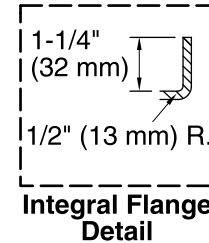

### Required Electrical Service

Two dedicated circuits required, protected with Class A Ground-Fault Circuit-Interrupter (GFCI). Outside North America, this device may be known as a Residual Current Device (RCD).

Pump: 120 V, 15 A, 60 Hz  
Heater: 120 V, 15 A, 60 Hz

### Technical Information

All product dimensions are nominal.

Installation: Three-wall alcove  
Drain location: Left  
Basin area, bottom: 50-3/8" x 19-5/8" (1280 mm x 498 mm)  
Basin area, top: 57-5/16" x 24-1/16" (1456 mm x 611 mm)  
Weight: 120 lbs (54.4 kg)  
Minimum floor load: 47 lbs/ft<sup>2</sup> (229.5 kg/m<sup>2</sup>)  
Water depth: 15-5/16" (389 mm)  
Water capacity: 66 gal (249.8 L)  
Electrical component rating: Pump: 120 V, 7 A, 60 Hz  
Heater: 120 V, 12.5 A, 60 Hz, 1500 W  
Pump speed: Single  
Minimum flat for door: 2-3/16" (55 mm)

### Notes

Measure your actual product for rough-in details. Install this product according to the installation instructions.

The hot water supply should be 70% of the capacity of the bath or greater. Installations will vary.

ADA compliant when installed to the specific requirements of these regulations.