

## Features

- Lid design conceals toilet seat to create a clean, sleek look
- Grip-Tight installation hardware makes it easy to fasten the seat – everything is done from above the bowl
- Grip-Tight bumpers hold seat firmly in place
- ReadyLatch® hinge provides a positive lock/unlock latch to securely hold seat in position, yet seat easily removes for cleaning or adjusting fit
- Single-hinge cover simplifies cleaning
- Quiet-Close™ round-front lid and seat prevents slamming
- Contoured seat for user comfort
- Color-matched plastic hinges

## Material

- Plastic construction

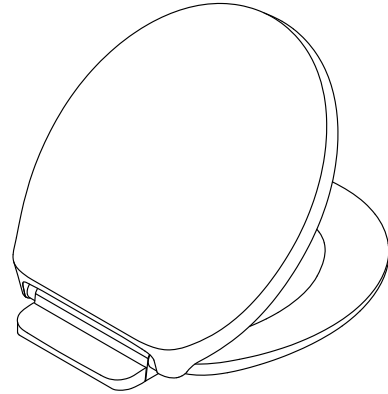

## Codes/Standards







IAPMO/ANSI Z124.5

## KOHLER® Toilets and Seats Limited Warranty

See website for detailed warranty information.

## Available Colors/Finishes

*Color tiles intended for reference only.*

| Color   | Code | Description   |
|---|------|---------------|
|  | 0    | White         |
|  | 96   | Biscuit       |
|  | NY   | Dune          |
|  | 95   | Ice™ Grey     |
|  | 58   | Thunder™ Grey |
|  | 7    | Black Black™  |

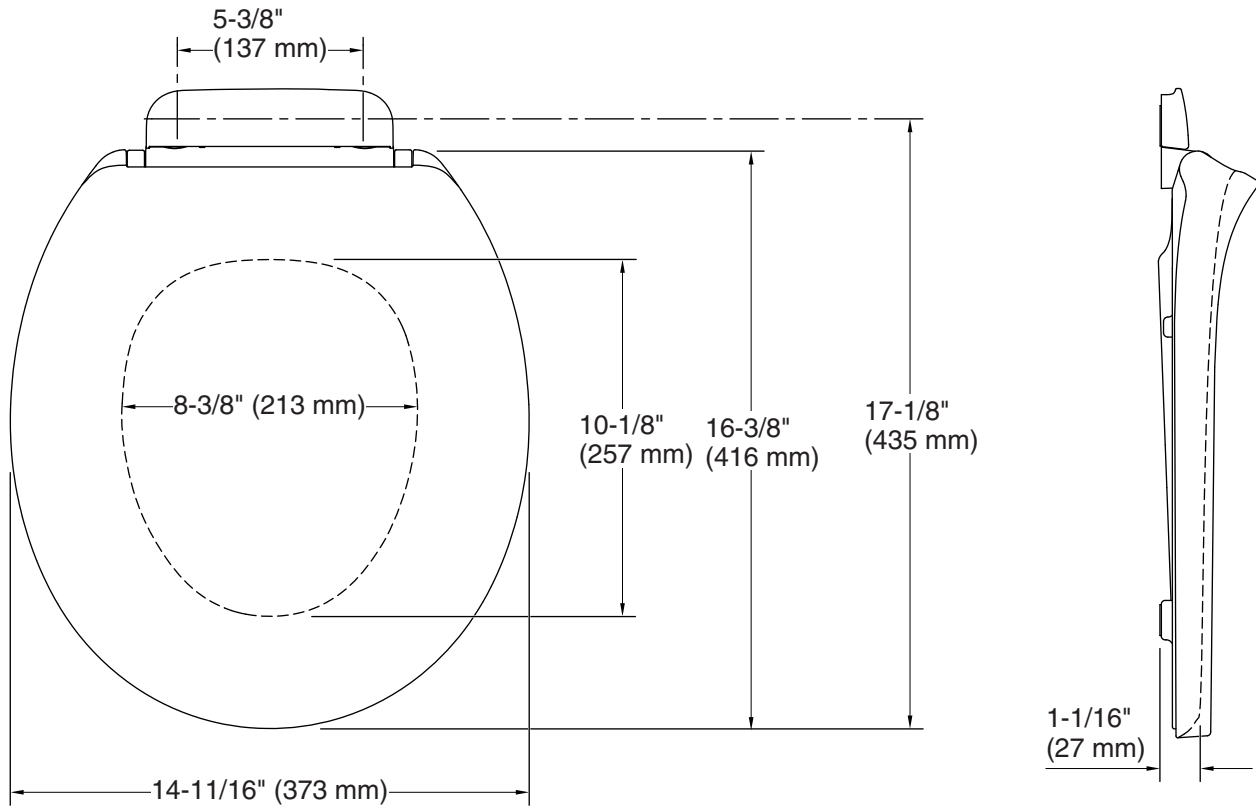

### Technical Information

All product dimensions are nominal.

Seat shape type: Round-front  
Seat front type: Closed-front  
Seat-mounting holes: 5-7/16" (137 mm)

### Notes

Install this product according to the installation instructions.