

INSTALLATION INSTRUCTIONS FOR P1161-077-L

For LED wall mount Fixture

WARNING! SHUT POWER OFF AT FUSE OR CIRCUIT BREAKER.

AVERTISSEMENT! COUPER LE COURANT AU NIVEAU DES FUSIBLES OU DO DISJONCTEUR.

PREPARATION

1. Shut off power at the fuse box or circuit breaker box. If necessary remove the old fixture and mounting hardware.
2. Carefully unpack your new fixture and lay out all the parts on a clear area. Take care not to lose any small parts necessary for installation.

ASSEMBLING THE FIXTURE (Fig.1)

3. Attach the mounting plate (A) to the junction box with junction box screws (B) (Size: 8-32*1/2"L). The side of the mounting plate marked "GND" must face out.

CONNECTION THE WIRES (Fig. 2)

4. Connect the electrical wires as shown in Fig.2, making sure that all wire nuts are secured. If your outlet has a ground wire (green or bare copper), connect the fixture's ground Wire to it. Otherwise, connect the fixture's ground wire directly to the circular strap using the green screw provided. Tuck the wire connections neatly into the junction box.

FINISHING THE INSTALLATION (Fig. 1)

5. Align Fixture (E) to mounting plate (A) and secure with screws (D).

Your installation is now complete. Return power to the junction box and test the fixture.

CAUTION /ATTENTION: When handling the fixture, do not apply pressure to the LEDs. Hold the fixture by the base or fixture body (E) only.

Replacing LED module (Fig.3)

The LED module can be replaced by a qualified electrician without cutting of wire and without damage to any decorative element to which the fixture is attached. See installation steps for more details (Fig 3.)

Warning: Turn off power at the circuit breaker before replacing LED module.

- a. Loosen screws (D), remove the wire nuts and place the fixture on a clear flat surface.
- b. Loosen screws (P), screws (M), wire fastener (N) and then remove LED module (I) carefully.
- c. Reverse steps a-b for installing the new LED module.

Note: The LED module should be provided by a specified supplier.

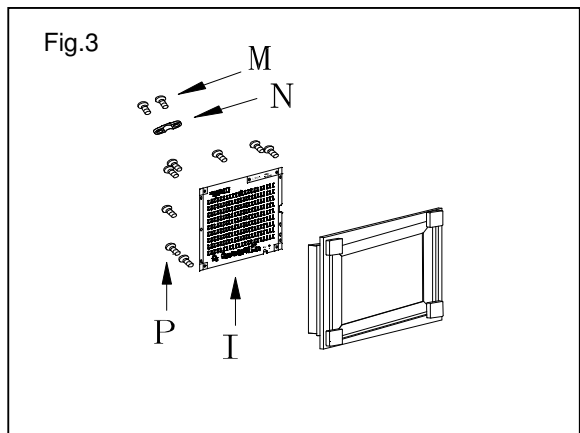
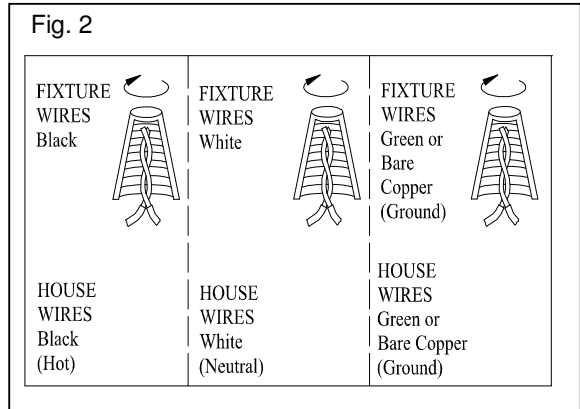
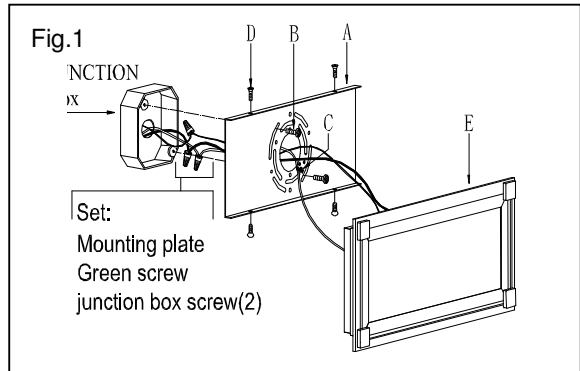

IMPORTANT: Fixture should be installed by a qualified electrician to ensure proper wiring and installation.

Dimmable with C-L (CFL & LED) type and Incandescent/Halogen type dimmers

