

Eleganza Vanity Item #H276

Features:

- Wall-mount wooden undercounter double vanity
- Finger pull opening on two large drawers and two small drawers
- Soft-closing full-extension drawer slides with weight capacity of 100 lbs.
- Features precision mitering and dovetail drawer construction
- Large drawer has lower back for plumbing
- Main vanity body constructed of veneered high-grade plywood
- Optional legs sold separately by single piece
- Countertop & washbasin sold separately
- Customizable (please request a quote)
- Handmade in USA
- Manufactured with low VOC finishes and wood from renewable forests



Recommended Accessories:

- Item #H276T: Countertop for Eleganza vanity #H276
- Cutout for washbasin #H270
- Faucet hole options: None, One, Two, or Three in 8" spread
- Item #H270: Under-mounted washbasin with overflow
- Recommended oversized European drain (i.e. item #7100-12 or 7100-16OF)
- Item #H27LEG solid wood leg artistically stained and painted to match the vanity, sold by piece

Finish Options:

- 02 - Natural Cherry
- 06 - Wenge
- 07 - Natural Walnut
- 08 - Matte White (TEX1 - fine texture)
- 16 - Matte Black (TEX1 - fine texture)
- 18 - Ebony
- 20 - Ash Gray
- 22 - Gray Zebra
- 24 - Classic Walnut
- 31 - White Oak
- 33 - African Mahogany
- 34 - Matte Mocha (TEX1 - fine texture)
- 35 - Matte Ardesia (TEX1 - fine texture)
- 36 - Espresso
- 37 - Weathered Oak
- 52 - Silver Oak
- 85 - Gloss White
- 86 - Gloss Black
- 87 - Gloss Mocha
- 88 - Gloss Ardesia

Product Specifications:

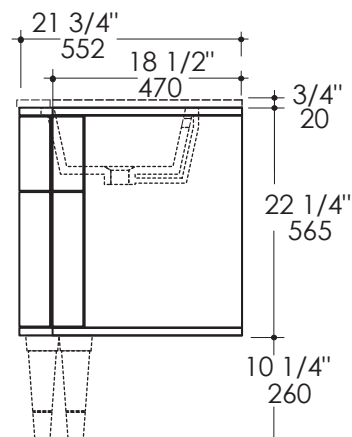
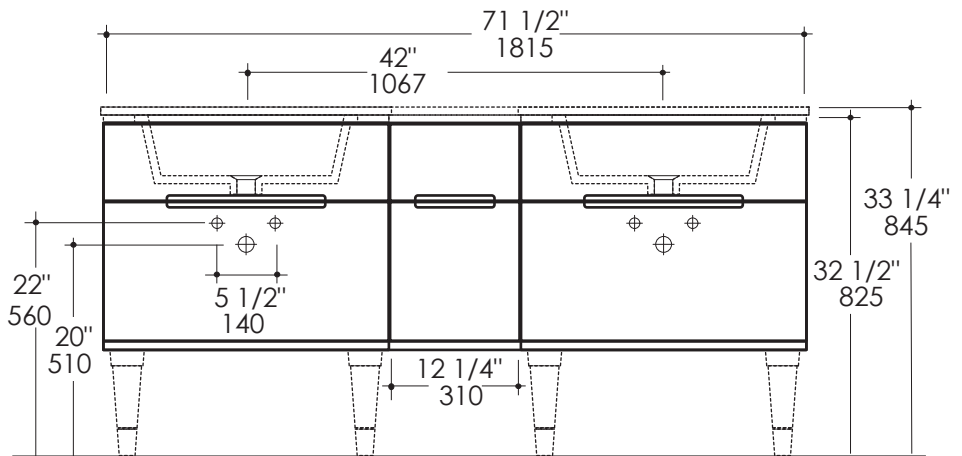

Notes:

Drawings provided herein are meant to give the user an idea of the product and are not made to scale. The size in inches is rounded up to the nearest 1/16". Slight variances can often occur with porcelain and woodwork. Therefore, LACAVA will not be held responsible for any cutouts, countertops, or furniture made without the actual product or template from LACAVA. Differences in color, grain, appearance and texture are inherent in all natural woodwork, and should be expected. Variances in these qualities are not deemed manufacturing defects, and will not be accepted as valid reasons to return or exchange any LACAVA woodwork. Plumbing specifications are only a guideline and may need to be altered based on the application.

LACAVA is committed to the highest level of customer service. Please feel free to contact us at 1-888-522-2823 (toll free) or by email at info@lacava.com for technical assistance or any general inquiries.