

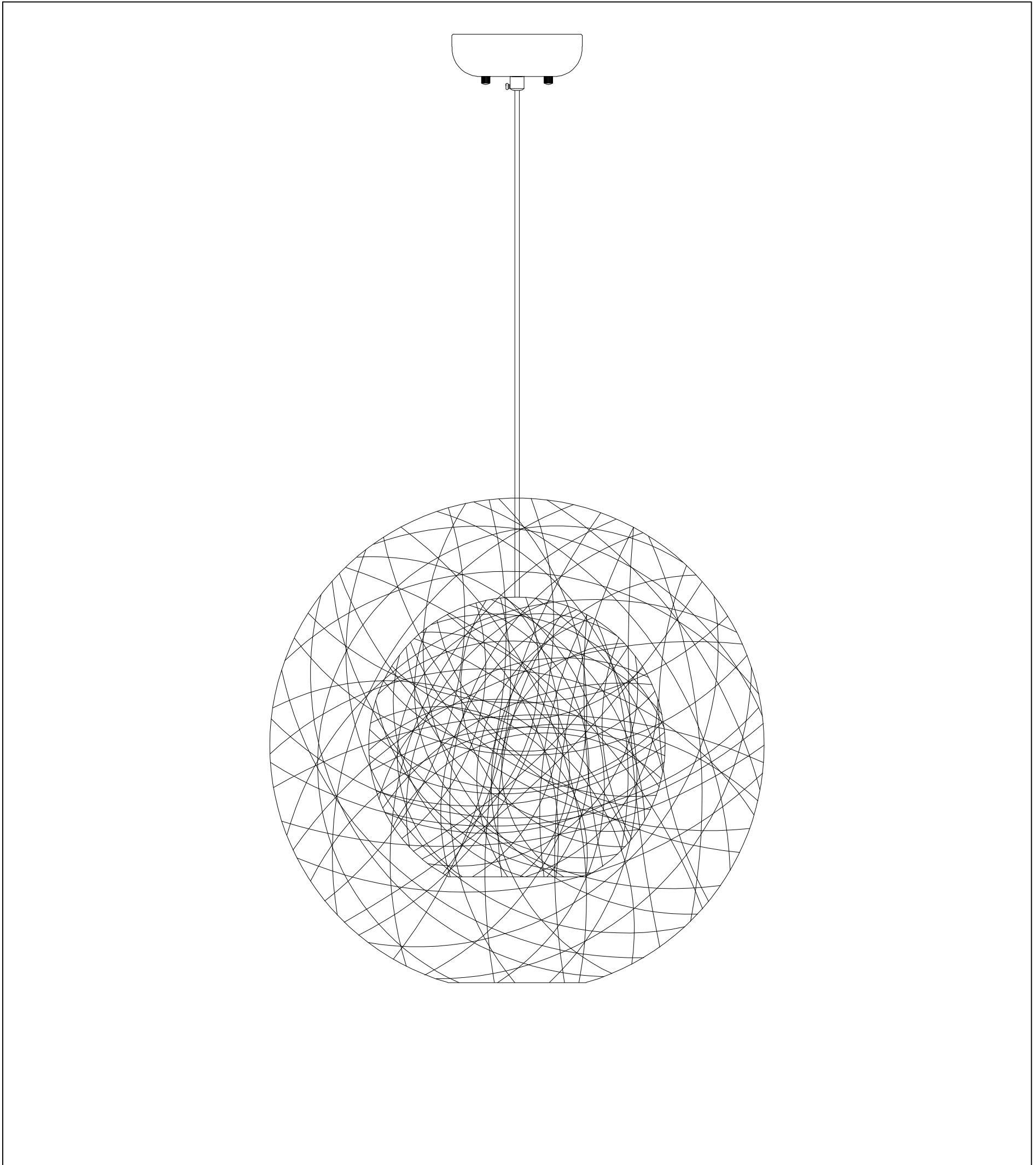

**PRODUCT NAME: Bali**  
**ITEM NUMBER: 14405CHWT**

**Please consult your electrician for hanging fixture and wiring.**



**E26 1X60W**

**PRODUCTS ARE NOT INENDED  
FOR COMMERCIAL USE.**

**MADE IN CHINA  
Page 1 of (2)**

**IMPORTANT: Turn off the power at the main fuse or circuit breaker box before starting installation**



Bracket (A)

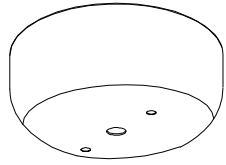

Canopy (B)



Finial (C)

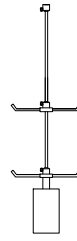

Body (D)

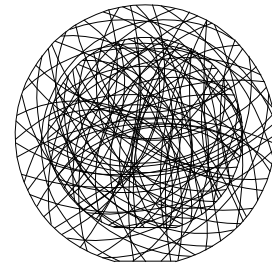

Shade (E)

**Locate all hardware & components before discarding packaging**

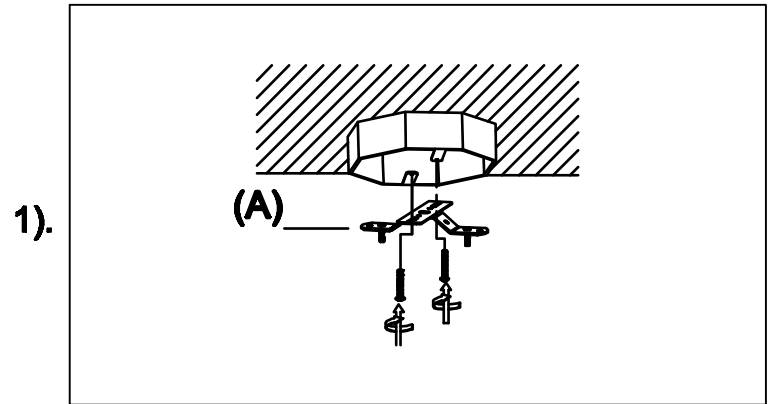
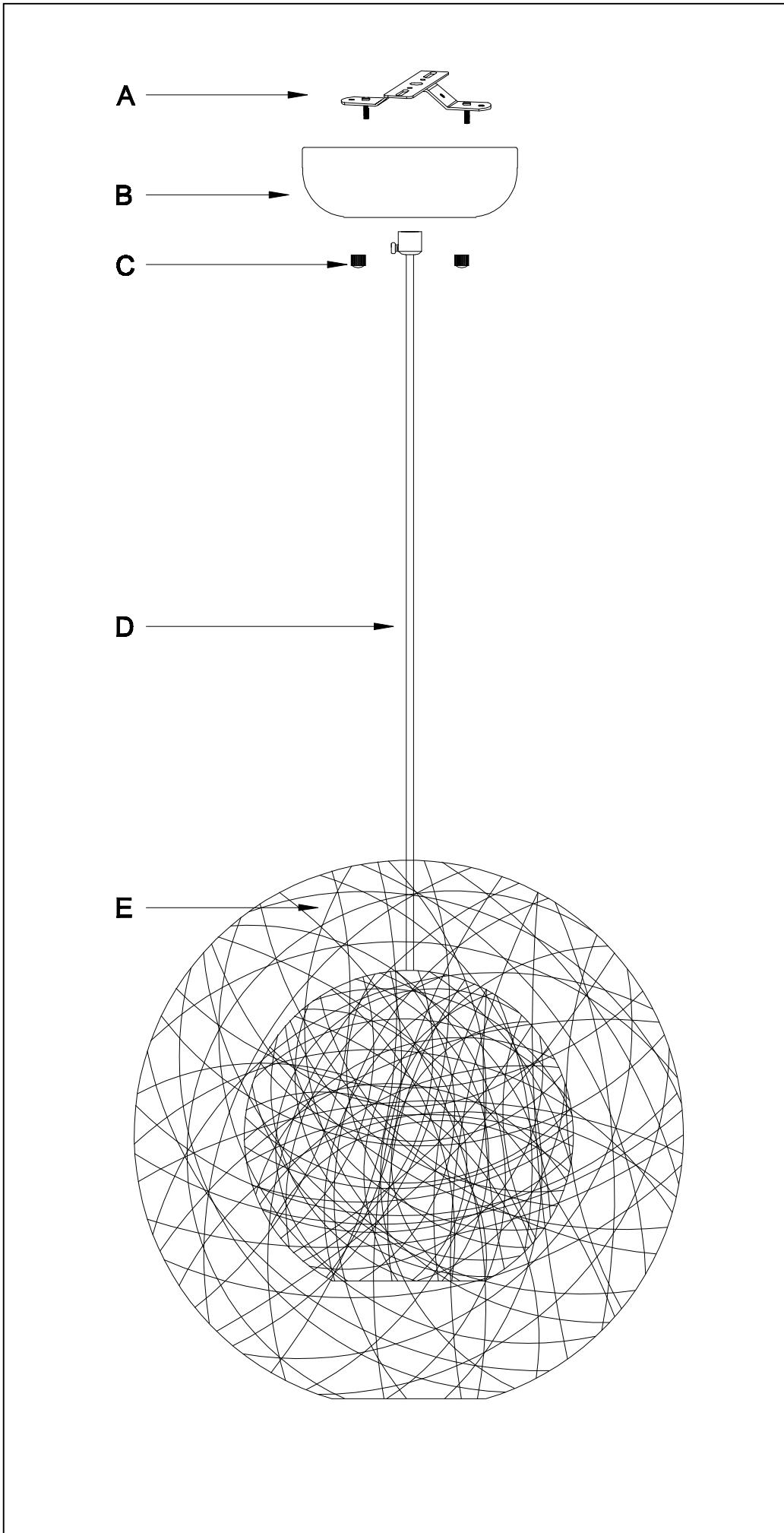

**Step.1: Remove mounting bracket(A) from fixture and install to electrical box.**

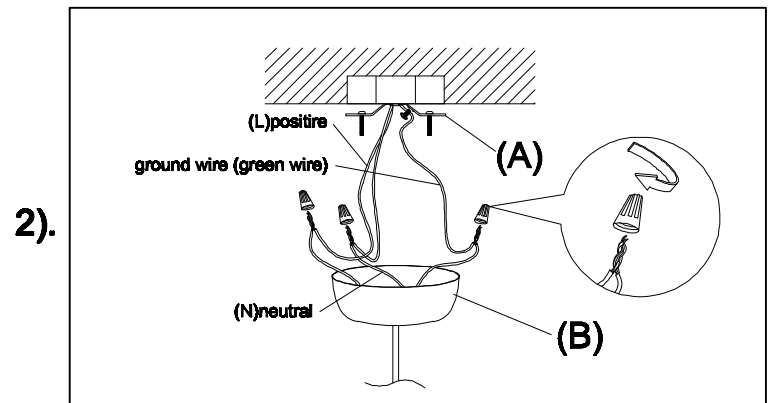

**Step.2: Wire fixture to wires in outlet box. Green wire is for Ground.**

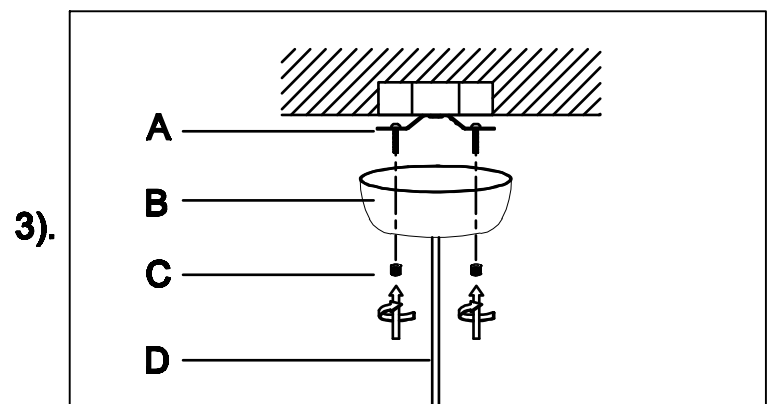

**Step.3: Adjust cable length to desired mounting height, and tighten strain relief screws to secure. Install body(C) to bracket(A) and tighten finials(C) on the canopy(B) to secure.**

**Cleaning & Care:**

Clean with soft cloth and a mild detergent.  
Do not use abrasive cleaner.