

# NIR-4

## 4" Iolite Retrofit Reflectors

Source: 14W LED

800lm or 1000lm

### PRODUCT DESCRIPTION

4" Iolite retrofit reflectors can be specified for use in new construction or remodel applications. The die-cast aluminum reflectors are available in square and round designs, with sharp and clean edges. Reflectors ship with a 60° optic installed, 25° and 38° optics are included and can be easily changed in the field. The reflectors produce 800lm or 1000lm output at 90+ CRI, utilizing 14W.

### FEATURES

- Retrofit existing 4" recessed housings
- Cree® LED COB or Comfort Dim Technology
- 2700K, 3000K, 3500K, 4000K or 5000K @ 90+ CRI
- 60° (Flood) optic installed, 38° (Narrow flood) and 25° (Spot) optics included
- 5-Year limited warranty

### SPECIFICATION

**Construction:** Reflectors are constructed of heat dissipating, die-cast aluminum. The aluminum die-cast LED heat sink is threaded to fit the reflector and transfer heat.

### Reflectors:

NIR-4RG / NIR-4SG: Adjustable surface gimbals adjust up to 40° (varies by housing).  
 NIR-4RC / NIR-4SC: Regressed cone reflectors optimize visual cut-off and adjust up to 40° (varies by housing).  
 NIR-4RNB / NIR-4SNB: Bullnose reflector with a filleted aperture which allows for minimal aperture brightness.

**Mounting:** Reflector includes friction blades to mount securely in most 4" housings.

**Field Changeable Optics:** Each reflector comes with a 60° (installed), 38° and 25° optics (included). Premium TIR optics are also available in 15° or 25°, see page 2.

**Retrofit:** Iolite retrofit series includes medium base screw-socket adapter (NRA-211SM) for retrofitting into existing medium base downlight housings. GU24 socket adapter is available for use with GU24 housings, must specify NRA-212SM.

### ELECTRICAL

**Lumens / Wattage:** 800lm / 14W or 1000lm / 14W  
**Color Temperature:** 2700K, 3000K, 3500K, 4000K, 5000K  
**CRI:** 90+ CRI  
**Operating Temp.:** 0°C to 40°C ambient temperature  
**Lifetime:** 50,000 hours @ L70  
**Comfort Dim:** Comfort Dim color tunes the temperature from a bright 3100K, to a romantic and comfortable 2000K on a gradual, even curve. Available in 800lm only.  
**Dimming:** Triac or ELV

### COMPATIBLE HOUSINGS

Retrofit reflectors are compatible with most 4" IC and Non-IC housings manufactured by Nora Lighting and others.

CATALOG NO.	DESCRIPTION
NFBIC-4LMRAT	ICAT Dedicated LED Fire Box
NFBIC-4INCAT	ICAT Line Voltage Fire Box
NHIC-4LMRAT	ICAT Dedicated LED New Construction
NSIC-401QAT	ICAT Line Voltage New Construction
NS-401QAT	AT Line Voltage New Construction
NHIC-4G24AT	ICAT GU24 New Construction
NHRIC-4LMRAT	ICAT Dedicated LED Remodel
NSRIC-401QAT	ICAT Line Voltage Remodel
NSR-404QAT	AT Line Voltage Remodel
NHRIC-4G24AT	ICAT GU24 Remodel

**Accessories:** Reflectors will accommodate (1) hex louver and (1) translucent deco collar or opaque snoot, no accessory holder is required, see page 2.

### LABELS AND LISTINGS

- cULus classified for Damp Location (Adjustable)
- cULus classified for Wet Location (Non-Adjustable)
- ENERGY STAR certified
- 5-Year Limited Warranty
- RoHS Compliant



Type

Project

Catalog No.

Notes

### PRODUCT IMAGES & DIMENSIONS

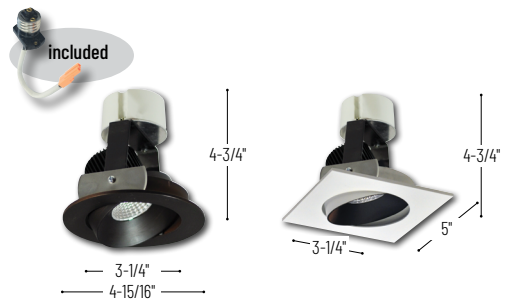

**NIR-4RC**  
 Round Cone Regress  
 40° Adj. (varies by housing)  
 BB, BW, BZ, HW, MPW, NN, WW

**NIR-4SC**  
 Square Cone Regress  
 40° Adj. (varies by housing)  
 BB, BW, BZ, HW, MPW, NN, WW

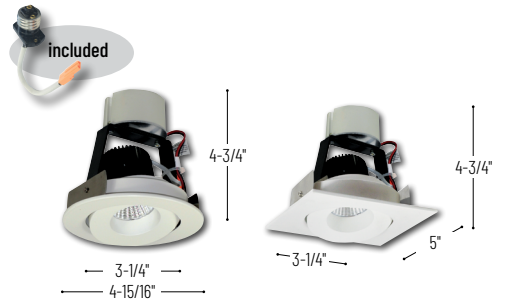

**NIR-4RG**  
 Round Adj. Surface Gimbal  
 40° Adj. (varies by housing)  
 BB, BZ, MPW, NN, WW

**NIR-4SG**  
 Square Adj. Surface Gimbal  
 40° Adj. (varies by housing)  
 BB, BZ, MPW, NN, WW

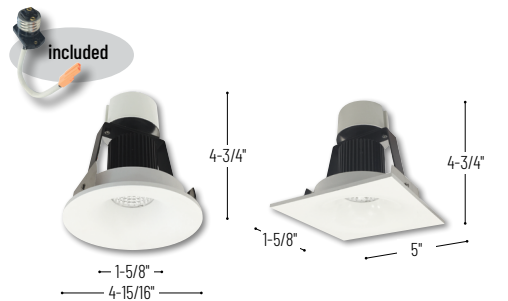

**NIR-4RNB**  
 Round Bullnose  
 Non Adjustable  
 BB, BZ, MPW, NN, WW

**NIR-4SNB**  
 Square Bullnose  
 Non Adjustable  
 BB, BZ, MPW, NN, WW

## 4" Iolite Retrofit Reflectors

Aperture	Reflector Style	Color Temp.	Finish <sup>1</sup>	Lumens
<b>NIR-4R</b> = Round	<b>C</b> = Adjustable Cone Regress	<b>27X</b> = 2700K	<b>BB</b> = Black / Black	<b>(blank)</b> = 800lm
<b>NIR-4S</b> = Square	<b>G</b> = Adjustable Surface Gimbal	<b>30X</b> = 3000K	<b>BW</b> = Black / White	<b>/10</b> = 1000lm
	<b>NB</b> = Non-Adjustable Bullnose	<b>35X</b> = 3500K	<b>BZ</b> = Bronze / Bronze	
		<b>40X</b> = 4000K	<b>HW</b> = Haze / White	
		<b>50X</b> = 5000K	<b>MPW</b> = Matte Powder White	
		<b>CDX</b> = Comfort Dim <sup>†</sup>	<b>NN</b> = Natural Metal / Natural Metal	
			<b>WW</b> = White / White	

<sup>†</sup> Comfort Dim technology available in 800lm & uses non-Cree COB modules. 1" & 2" Iolite uses a different dimming curve than 4" Comfort Dim  
<sup>1</sup> Not all finishes are available on all reflectors

Example: **NIR-4RG27XWW** = 4" Iolite Retrofit Round Adjustable Surface Gimbal, 2700K, White finish, 800lm

## 4" Iolite Retrofit Accessories

Iolite Accessories can be added at any point in the design process.  
Accessories easily install between module and die-cast reflector.

Type \_\_\_\_\_

Project \_\_\_\_\_

Catalog No. \_\_\_\_\_

Notes \_\_\_\_\_



### Frosted Filter-Optic

NIO-REFL15FR 15° Optic  
NIO-REFL25FR 25° Optic  
NIO-REFL38FR 38° Optic  
NIO-REFL60FR 60° Optic

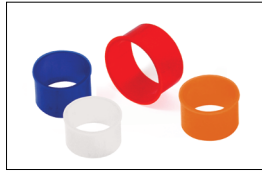

### Translucent Deco Collar

NIO-AS14(color) 5/8"  
NIO-AS19(color) 3/4"  
NIO-AS26(color) 1"

Color:  
BLU Blue, AM Amber, FR Frost, R Red

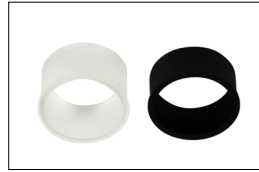

### Opaque Collar Snoot

NIO-AS14(color) 5/8"  
NIO-AS19(color) 3/4"  
NIO-AS26(color) 1"

Color: BLK Black, MPW Matte Powder  
White, WH White

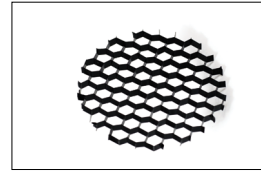

### Hex Cell Louver

NIO-HC  
Hex cell louver subtly reduces  
aperture brightness by reducing light  
output by about 20%



### Premium TIR Optics

NIO-REFLTIR15 15° Optic  
NIO-REFLTIR25 25° Optic

TIR optics are not compatible with  
Comfort Dim technology.



### Medium Base Retrofit Adapter

NRA-211SM

Medium base socket included with  
each luminaire.

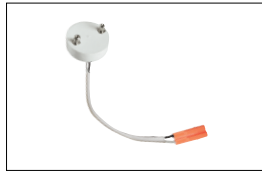

### GU24 Retrofit Adapter

NRA-212SM

GU24 adapter replaces medium base  
socket adapter.