

INSTALLATION INSTRUCTIONS

For Model : 72502-L

READ AND SAVE THESE INSTRUCTIONS

WARNING! SHUT POWER OFF AT FUSE OR CIRCUIT BREAKER.

AVERTISSEMENT! COUPER LE COURANT AU NIVEAU DES FUSIBLES OU DU DISJONCTEUR.

HANGING THE FIXTURE (Fig. 1)

1. Shut off the power at the circuit breaker and remove the old fixture, including the mounting hardware.
2. Carefully unpack your new fixture and lay out all the parts on a clear area. Take care not to lose any small parts necessary for installation.
3. Thread the 2 mounting screws (C) into the mounting plate (D) (part #:A-020) spaced the same distance apart as the holes in the fixture back plate(F). The length of screws (C) into mounting plate (D) may be adjusted if necessary.
4. Attach the mounting plate (D) to the outlet box (A) (not supplied) with outlet box screws (E). (Size: #8-32*1/2L).
Note: The side of mounting plate marked "GND" must face out.

CONNECTING THE WIRES (Fig. 2)

5. Connect the electrical wires as shown in Fig.2. Making sure that all wire connectors(B) are secured. If your outlet box has a ground wire (green or bare copper), connect the fixture's ground wire to it. Otherwise, connect the fixture's ground wire directly to the circular strap using the green screw provided.

COMPLETING THE INSTALLATION (Fig.1)

6. Align the fixture body to mounting plate (D) and secure with Rubber washers (G) and cap nuts (H).
7. To prevent moisture entering the outlet box and causing a short, use clear caulking (i.e. Indoor/Outdoor Silicone Sealant) to outline the outside of fixture back plate where it meets the wall leaving a space at bottom to allow moisture a means to escape. (Fig. 3)
8. Bulb information: (2 x AC LED 10W included.)

**DO NOT EXCEED THE MAXIMUM WATTAGE RATING!
(NE PAS DEPASSER LA PUISSANCE NOMINALE MAXIMALE!)**

Replacing LED module (Fig. 4)

The LED module can be replaced by a qualified electrician without cutting of wire and without damage to any decorative element to which the fixture is attached. See installation steps for more details (Fig 4.) Shut off power at the circuit breaker and remove the fixture from the wall.

- a. Remove the metal cover (S) by unscrewing from the fixture body (I), and then loosen screws (M) to remove the metal cup (K). Carefully pull out the wires (J) and disconnect the LED module from the fixture.
- b. Remove the module cover (Q), glass (P), module ring (O), the LED module (N) by loosening screws (R).
- c. Carefully remove the LED module (N) for re-lamping. Note: The LED module should be provided by a specified supplier.
- d. For better heat dissipation the LED module (N) should be installed with the heat transfer material (L) when re-lamping

Your installation is now complete. Return power to the junction box and test the fixture

Note: Illustration (Fig. 1) on this manual is for installation purposes only. It may or may not be identical to the fixture purchased.

Fig. 1

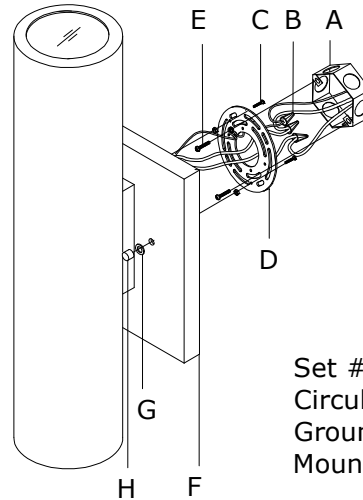

Fig. 2

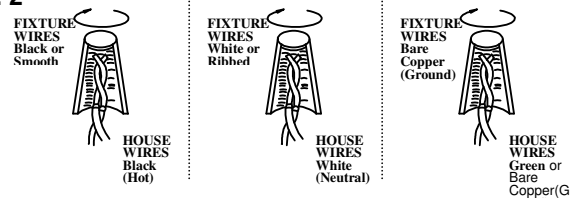

Fig. 3

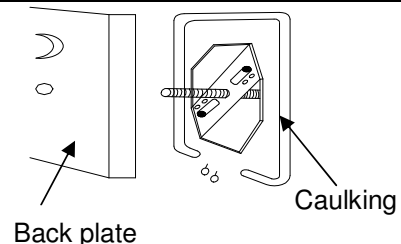

Fig. 4

