

⚠ WARNING/CAUTION

- **DISCONNECT POWER BEFORE RE-LAMPING OR WIRING THE FIXTURE. READ ALL INSTRUCTIONS COMPLETELY BEFORE STARTING INSTALLATION.**
- **TO AVOID THE RISK OF FIRE OR SHOCK, FIXTURE MUST BE INSTALLED IN COMPLIANCE WITH ALL APPLICABLE NATIONAL AND LOCAL ELECTRICAL/BUILDING CODES. THE INSTALLATION AND MAINTENANCE OF THIS UNIT SHOULD BE COMPLETED BY A LICENSED ELECTRICIAN OR CERTIFIED FACTORY TRAINED TECHNICIAN.**
- **CALIFORNIA PROP 65: THIS LIGHTING FIXTURE CONTAINS CHEMICALS KNOWN TO THE STATE OF CALIFORNIA TO CAUSE CANCER, BIRTH DEFECTS, AND/OR OTHER REPRODUCTIVE HARM. WASH HANDS AFTER USE.**
- **REMOVE THE FIXTURE, PARTS AND PARTS BAG(S) FROM THE CARTON. BEFORE DISCARDING THE CARTON, DOUBLE CHECK TO MAKE CERTAIN THAT ALL PARTS ARE FOUND. INSPECT THE FIXTURE PRIOR TO INSTALLATION FOR ANY DAMAGE TO THE FIXTURE.**
- **DIMMING: THE FIXTURE CAN BE CONTROLLED BY A WALL DIMMING DEVICE. ONLY USE TRIAC/ELECTRONIC DIMMER. MAKE SURE THE CARTON IS MARKED FOR USE WITH LED COMPACT FLUORESCENT-INCANDESCENT LIGHT SOURCE ONLY. THESE CAN BE PROVIDED BY YOUR LOCAL ELECTRICAL DISTRIBUTOR, HOME CENTER, OR HARDWARE STORE.**
- **PLEASE CLEAN WITH A SOFT, DRY CLOTH ONLY! DO NOT USE CLEANSERS**

FIXTURE INSTALLATION

1. Attach the MOUNTING PLATE (1) onto the junction box using the MOUNTING SCREWS (2). This fixture is designed to be mounted on standard round or octagon junction box. The junction box must be securely mounted to the structure of the building.
2. Attach the Ground wire (Green) to the ground inside the outlet box (Generally green or bar copper wire) or the GROUND SCREW (3) on the MOUNTING PLATE (1). **NEVER CONNECT GROUND WIRE TO "HOT" WIRE! FAILURE TO FOLLOW THIS COULD RESULT IN SERIOUS INJURY OR DEATH!**
3. Connect the white fixture lead to the neutral (Generally white) wire in the outlet box. Fasten the wires together with an approved fastener (WIRE NUT) (4). Starting 1" below the fastener, tightly wrap the connection with electrical tape so that the connections seals the end of the fastener. **MAKE SURE THERE ARE NO EXPOSED WIRE OF STRANDS THAT COULD CAUSE A DANGEROUS SHORT CIRCUIT!**
4. Connect the black fixture leads to the hot (Generally black) wire in the junction box. Fasten the joined wires same as previous step. **NEVER REVERSE HOT AND NEUTRAL WIRES. FAILURE TO FOLLOW THIS COULD RESULT IN SERIOUS INJURY OR DEATH!**
5. **To prevent water from flowing into the outlet box, put a bead of weatherproof caulking or silicone sealant around the inside edge of the back. DO NOT PLUG THE DRAIN HOLE (10)!**
6. Attach the FIXTURE ASSEMBLY(6) to the MOUNTING PLATE (1) and secure with the SET SCREWS (5).
7. Screw the BULBS (7)(not included) up into the SOCKET of the fixture. **THIS FIXTURE IS RATED FOR 60 WATT TYPE B LAMP. DO NOT EXCEED THE RECOMMENDED WATTAGE!**
8. Lift the GLASS (8) up onto the fixture and secure using the FINAL (9).
9. Restore power to the outlet at the breaker or fuse box.

ITEM	DESCRIPTION	PART NUMBER
1	MOUNTING PLATE	HDW-B1142
2	MOUNTING SCREWS	HDW-B1142
3	GROUND SCREW	HDW-B1142
4	WIRE NUTS	HDW-B1142
5	#8-32 SET SCREWS	HDW-B1142
6	FIXTURE ASSEMBLY	FAS-B1142
7	BULBS	NOT INCLUDED
8	GLASS	GLS-B1142
9	FINAL	FIN-B1142

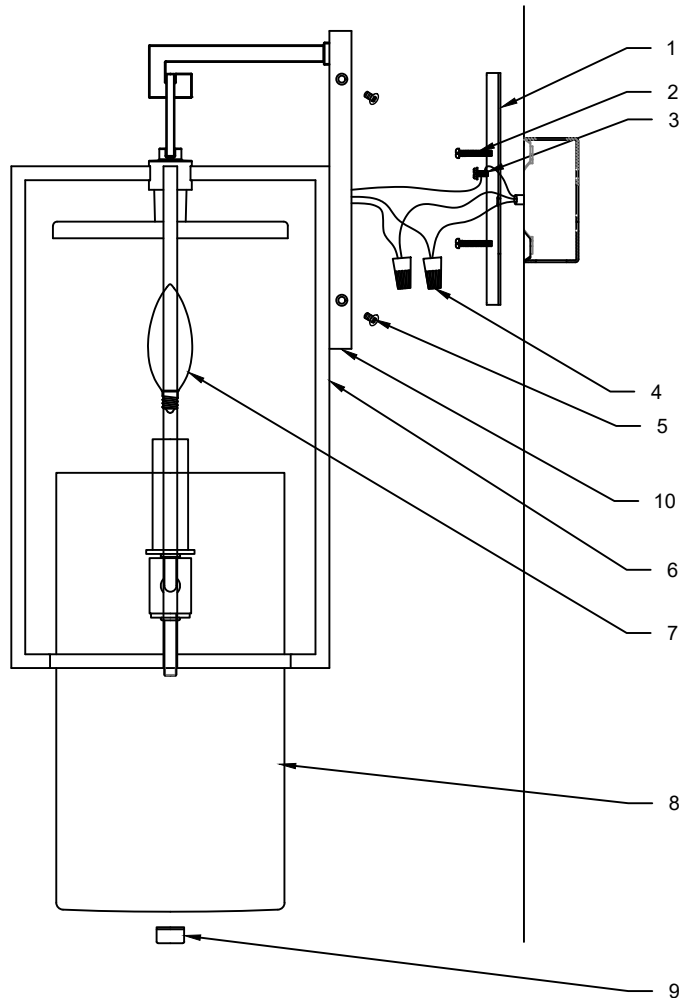

⚠ ATTENTION PRUDENCE

- DÉBRANCHEZ L'ALIMENTATION AVANT DE REMPLIR OU DE CÂBLER LE LUMINAIRE. LISEZ COMPLÈTEMENT TOUTES LES INSTRUCTIONS AVANT DE COMMENCER L'INSTALLATION
- POUR ÉVITER LE RISQUE D'INCENDIE OU D'ÉLECTROCUTION, LE LUMINAIRE DOIT ÊTRE INSTALLÉ CONFORMÉMENT À TOUS LES CODES ÉLECTRIQUES/DE CONSTRUCTION NATIONAUX ET LOCAUX APPLICABLES. L'INSTALLATION ET L'ENTRETIEN DE CET APPAREIL DOIVENT ÊTRE EFFECTUÉS PAR UN ÉLECTRICIEN AGRÉÉ OU UN TECHNICIEN CERTIFIÉ FORMÉ EN USINE.
- CALIFORNIE PROP 65 : CET APPAREIL D'ÉCLAIRAGE CONTIENT DES PRODUITS CHIMIQUES CONNUS PAR L'ÉTAT DE CALIFORNIE POUR PROVOQUER LE CANCER, DES MALADIES CONGÉNITALES ET/OU D'AUTRES DOMMAGES À LA REPRODUCTION. LAVER LES MAINS APRÈS UTILISATION.
- RETIRER LE LUMINAIRE, LES PIÈCES ET LE(S) SAC(S) DE PIÈCES DU CARTON. AVANT DE JETER LE CARTON, VÉRIFIEZ DOUBLE POUR VOUS ASSURER QUE TOUTES LES PIÈCES SONT TROUVÉES. INSPECTER LE LUMINAIRE AVANT L'INSTALLATION POUR TOUT DOMMAGE AU LUMINAIRE.
- GRADATION : LE LUMINAIRE PEUT ÊTRE CONTRÔLÉ PAR UN DISPOSITIF DE GRADATION MURALE. UTILISER UNIQUEMENT UN GRADATEUR TRIAC/ÉLECTRONIQUE. ASSUREZ-VOUS QUE LE CARTON EST MARQUÉ POUR UNE UTILISATION AVEC UNE SOURCE DE LUMIÈRE FLUORESCENTE À INCANDESCENTE COMPACTE UNIQUEMENT. CEUX-CI PEUVENT ÊTRE FOURNIS PAR VOTRE DISTRIBUTEUR ÉLECTRIQUE LOCAL, CENTRE À DOMICILE OU MAGASIN DE QUINCAILLERIE.
- VEUILLEZ NETTOYER UNIQUEMENT AVEC UN CHIFFON DOUX ET SEC ! N'UTILISEZ PAS DE NETTOYANTS

FIXTURE INSTALLATION

1. Attach the MOUNTING PLATE (1) onto the junction box using the MOUNTING SCREWS (2). This fixture is designed to be mounted on standard round or octagon junction box. The junction box must be securely mounted to the structure of the building.
2. Attach the Ground wire (Green) to the ground inside the outlet box (Generally green or bar copper wire) or the GROUND SCREW (3) on the MOUNTING PLATE (1). **NEVER CONNECT GROUND WIRE TO "HOT" WIRE! FAILURE TO FOLLOW THIS COULD RESULT IN SERIOUS INJURY OR DEATH!**
3. Connect the white fixture lead to the neutral (Generally white) wire in the outlet box. Fasten the wires together with an approved fastener (WIRE NUT) (4). Starting 1" below the fastener, tightly wrap the connection with electrical tape so that the connections seals the end of the fastener. **MAKE SURE THERE ARE NO EXPOSED WIRE OF STRANDS THAT COULD CAUSE A DANGEROUS SHORT CIRCUIT!**
4. Connect the black fixture leads to the hot (Generally black) wire in the junction box. Fasten the joined wires same as previous step. **NEVER REVERSE HOT AND NEUTRAL WIRES. FAILURE TO FOLLOW THIS COULD RESULT IN SERIOUS INJURY OR DEATH!**
5. To prevent water from flowing into the outlet box, put a bead of weatherproof caulking or silicone sealant around the inside edge of the back. **DO NOT PLUG THE DRAIN HOLE (10)!**
6. Attach the FIXTURE ASSEMBLY(6) to the MOUNTING PLATE (1) and secure with the SET SCREWS (5).
7. Screw the BULBS (7)(not included) up into the SOCKET of the fixture. **THIS FIXTURE IS RATED FOR 60 WATT TYPE B LAMP. DO NOT EXCEED THE RECOMMENDED WATTAGE!**
8. Lift the GLASS (8) up onto the fixture and secure using the FINAL (9).
9. Restore power to the outlet at the breaker or fuse box.

ITEM	DESCRIPTION	PART NUMBER
1	MOUNTING PLATE	HDW-B1142
2	MOUNTING SCREWS	HDW-B1142
3	GROUND SCREW	HDW-B1142
4	WIRE NUTS	HDW-B1142
5	#8-32 SET SCREWS	HDW-B1142
6	FIXTURE ASSEMBLY	FAS-B1142
7	BULBS	NOT INCLUDED
8	GLASS	GLS-B1142
9	FINAL	FIN-B1142